

MAVIC AIR 2

User Manual v1.4

2020.12

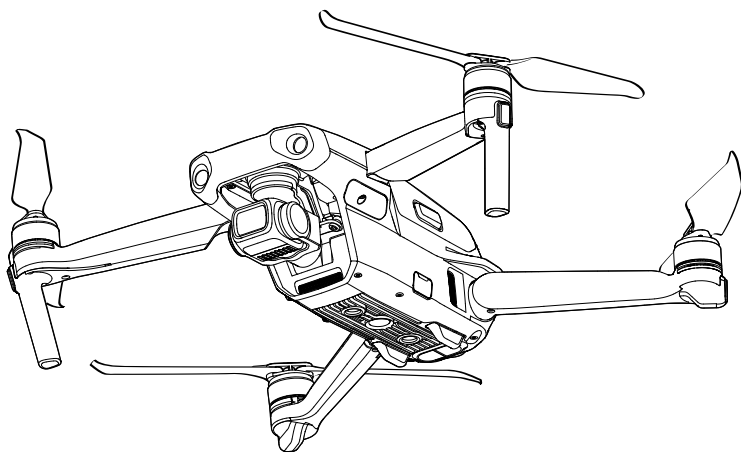

Searching for Keywords

Search for keywords such as “battery” and “install” to find a topic. If you are using Adobe Acrobat Reader to read this document, press Ctrl+F on Windows or Command+F on Mac to begin a search.

Navigating to a Topic

View a complete list of topics in the table of contents. Click on a topic to navigate to that section.

Printing this Document

This document supports high resolution printing.

Using this Manual

Legend



Warning



Important



Hints and Tips



Reference

Read Before the First Flight

Read the following documents before using the DJI™ MAVIC™ Air 2:

1. In the Box & Disclaimer and Safety Guidelines
2. Quick Start Guide
3. User Manual

It is recommend to watch all tutorial videos on the official DJI website and read the disclaimer and safety guidelines before using for the first time. Prepare for your first flight by reviewing the quick start guide and refer to this user manual for more information.

Video Tutorials

Go to the address below or scan the QR code to watch the Mavic Air 2 tutorial videos, which demonstrate how to use the Mavic Air 2 safely:

<http://www.dji.com/mavic-air-2/video>



Download the DJI Fly App

Make sure to use DJI Fly during flight. Scan the QR code on the right to download the latest version.

The Android version of DJI Fly is compatible with Android v6.0 and later. The iOS version of DJI Fly is compatible with iOS v10.0.2 and later.



For increased safety, flight is restricted to a height of 98.4 ft (30 m) and range of 164 ft (50 m) when not connected or logged into the app during flight. This applies to DJI Fly and all apps compatible with DJI aircraft.

Download DJI Assistant 2 for Mavic

Download DJI Assistant 2 for Mavic at <http://www.dji.com/mavic-air-2/downloads>.



- The operating temperature of this product is -10° to 40° C. It does not meet the standard operating temperature for military grade application (-55° to 125° C), which is required to endure greater environmental variability. Operate the product appropriately and only for applications that it meets the operating temperature range requirements of that grade.

Contents

Using this Manual	2
Legend	2
Read Before the First Flight	2
Video Tutorials	2
Download the DJI Fly App	2
Download DJI Assistant 2 for Mavic	2
Product Profile	6
Introduction	6
Preparing the Aircraft	6
Preparing the Remote Controller	7
Aircraft Diagram	8
Remote Controller Diagram	8
Activating Mavic Air 2	9
Aircraft	11
Flight Modes	11
Aircraft Status Indicators	11
Return to Home	12
Vision Systems and Infrared Sensing System	16
Intelligent Flight Mode	18
Flight Recorder	23
Propellers	23
Intelligent Flight Battery	24
Gimbal and Camera	28
Remote Controller	31
Remote Controller Profile	31
Using the Remote Controller	31
Linking the Remote Controller	35
DJI Fly App	37
Home	37
Camera View	38

Flight	42
Flight Environment Requirements	42
Flight Limits and GEO Zones	42
Pre-Flight Checklist	43
Auto Takeoff/Landing	44
Starting/Stopping the Motors	44
Flight Test	45
Appendix	47
Specifications	47
Calibrating the Compass	50
Firmware Update	51
After-sales Information	52

Product Profile

This section introduces Mavic Air 2 and lists the components of the aircraft and remote controller.

Product Profile

Introduction

DJI Mavic Air 2 features both an Infrared Sensing System and Forward, Backward, and Downward Vision Systems, allowing for hovering, flying indoors as well as outdoors, and automatic Return to Home. Capturing complex shots is made effortless with DJI signature technologies such as Obstacle Sensing and Advanced Pilot Assistance System 3.0. Enjoy Intelligent Flight modes such as QuickShots, Panorama, and FocusTrack, which include ActiveTrack 3.0, Spotlight 2.0, and Point of Interest 3.0. With a fully stabilized 3-axis gimbal and 1/2" sensor camera, Mavic Air 2 shoots 4K/60 fps video and 48 MP photos. Meanwhile, the updated Hyperlapse feature supports 8K timelapse.

Built into the remote controller is DJI's long-range transmission technology OCUSSYNC™ 2.0, offering a maximum transmission range of 6 mi (10 km) and displaying video from the aircraft to the DJI Fly app on a mobile device at up to 1080p. The remote controller works at both 2.4 GHz and 5.8 GHz, and it can select the best transmission channel automatically without any latency. The aircraft and camera can easily be controlled using the onboard buttons.

Mavic Air 2 has a maximum flight speed of 42 mph (68 kph) and a maximum flight time of 34 minutes, while the maximum runtime of the remote controller is six hours.



- Maximum flight time was tested in an environment with no wind while flying at a consistent 11 mph (18 kph) and the maximum flight speed was tested at sea level altitude with no wind. These values are for reference only.
- The remote controller reaches its maximum transmission distance (FCC) in a wide-open area with no electromagnetic interference at an altitude of about 400 ft (120 m). The maximum runtime was tested in a laboratory environment and without charging the mobile device. This value is for reference only.
- 5.8 GHz is not supported in some regions. Observe the local laws and regulations.

Preparing the Aircraft

All aircraft arms are folded before the aircraft is packaged. Follow the steps below to unfold the aircraft.

1. Remove the gimbal protector from the camera.
2. Unfold the front arms, and then unfold the rear arms.

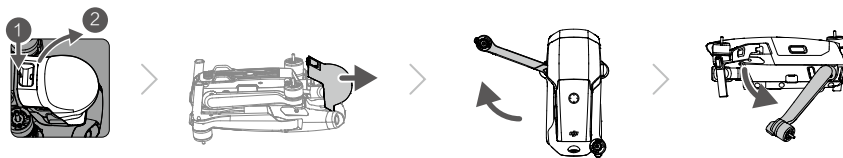

- Attach the gimbal protector when not in use.

3. Attaching the propellers.

Attach the propellers marked white to the motors with white marks. Press the propeller down onto the motors and turn until it is secure. Attach the other propellers to the unmarked motors. Unfold all the propeller blades.

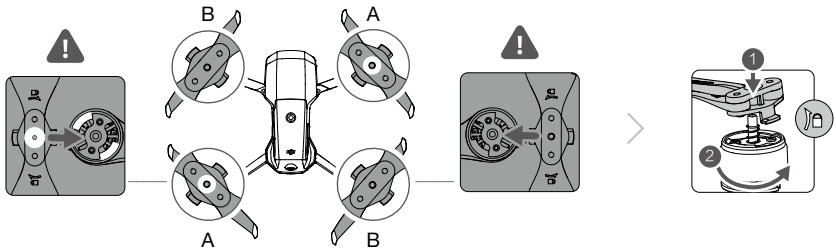

4. All Intelligent Flight Batteries are in hibernation mode before shipment to ensure safety. Use the provided charger to charge and activate the Intelligent Flight Batteries for the first time. It takes approximately 1 hour and 35 minutes to fully charge an Intelligent Flight Battery.

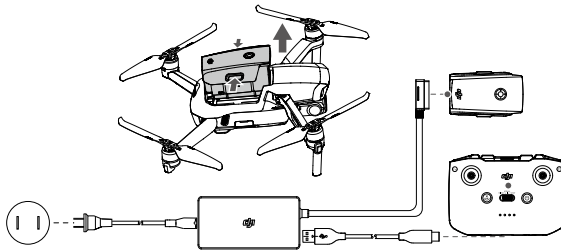

- ⚠ • Unfold the front arms before unfolding the rear arms.
- Make sure the gimbal protector is removed and all arms are unfolded before powering on the aircraft. Otherwise, it may affect the aircraft self-diagnostics.

Preparing the Remote Controller

1. Remove the control sticks from their storage slots on the remote controller and screw them into place.
2. Pull out the mobile device holder. Choose an appropriate remote controller cable based on the type of mobile device. A Lightning connector cable, Micro USB cable, and USB-C cable are included in the packaging. Connect the end of the cable with the phone logo to your mobile device. Make sure the mobile device is secured.

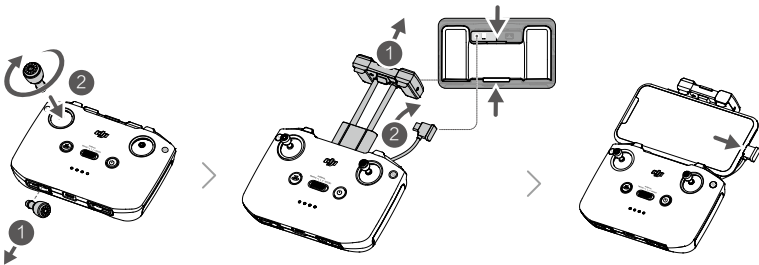

- ⚠ • If a USB connection prompt appears when using an Android mobile device, select the option to charge only. Otherwise, it may result in connection failure.

Aircraft Diagram

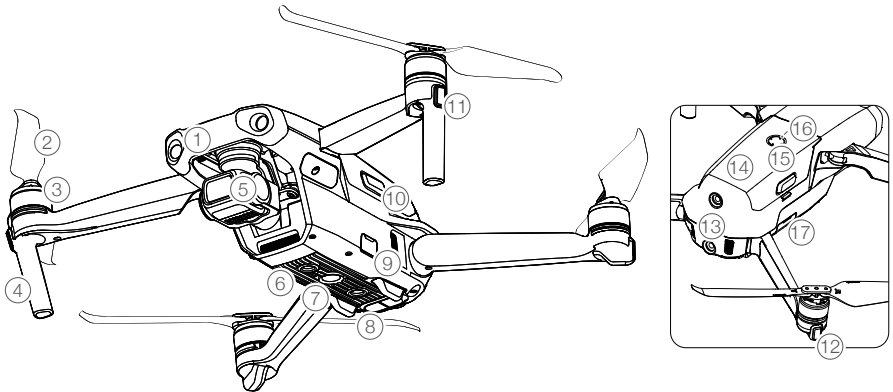

- | | |
|--------------------------------------|--------------------------------|
| 1. Forward Vision System | 10. Battery Buckles |
| 2. Propellers | 11. Front LEDs |
| 3. Motors | 12. Aircraft Status Indicators |
| 4. Landing Gears (Built-in antennas) | 13. Backward Vision System |
| 5. Gimbal and Camera | 14. Intelligent Flight Battery |
| 6. Downward Vision System | 15. Power Button |
| 7. Auxiliary Bottom Light | 16. Battery Level LEDs |
| 8. Infrared Sensing System | 17. microSD Card Slot |
| 9. USB-C Port | |

Remote Controller Diagram

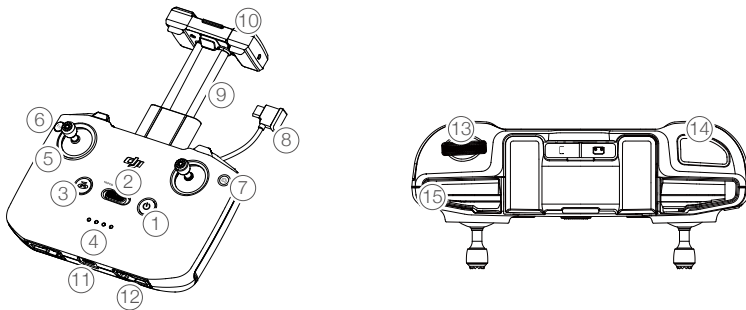

- | | |
|--|---|
| <p>1. Power Button</p> <p>Press once to check the current battery level. Press once, then again, and hold to turn the remote controller on or off.</p> | <p>3. Flight Pause/Return to Home (RTH) Button</p> <p>Press once to make the aircraft brake and hover in place (only when GPS or Vision Systems are available). Press and hold the button to initiate RTH. The aircraft returns to the last recorded Home Point. Press again to cancel RTH.</p> |
| <p>2. Flight Mode Switch</p> <p>Switch between Sport mode, Normal mode, and Tripod (Cine) mode.</p> | |

4. Battery Level LEDs

Displays the current battery level of the remote controller.

5. Control Sticks

Use the control sticks to control the aircraft movements. Set the flight control mode in DJI Fly. The control sticks are removable and easy to store.

6. Customizable Button

Press once to turn the Auxiliary Bottom Light on or off. Press twice to recenter the gimbal or tilt the gimbal downward (default settings). The button can be set in DJI Fly.

7. Photo/Video Toggle

Press once to switch between photo and video mode.

8. Remote Controller Cable

Connect to a mobile device for video linking via the remote controller cable. Select the cable according to the mobile device.

9. Mobile Device Holder

Used to securely mount the mobile device to the remote controller.

10. Antennas

Relay aircraft control and video wireless signals.

11. USB-C Port

For charging and connecting the remote controller to the computer.

12. Control Sticks Storage Slot

For storing the control sticks.

13. Gimbal Dial

Controls the tilt of the camera.

14. Shutter/Record Button

Press once to take photos or start or stop recording.

15. Mobile Device Slot

Used to secure the mobile device.

Activating Mavic Air 2

Mavic Air 2 requires activation before using for the first time. After powering on the aircraft and remote controller, follow the on-screen instructions to activate Mavic Air 2 using DJI Fly. An internet connection is required for activation.

Aircraft

This section introduces the flight controller, Forward, Backward and Downward Vision Systems, and the Intelligent Flight Battery.

Aircraft

Mavic Air 2 contains a flight controller, video downlink system, vision systems, infrared sensing system, propulsion system, and an Intelligent Flight Battery.

Flight Modes

Mavic Air 2 has three flight modes, plus a fourth flight mode that the aircraft switches to in certain scenarios. Flight modes can be switched via the Flight Mode switch on the remote controller.

Normal Mode: The aircraft utilizes GPS and the Forward, Backward, and Downward Vision Systems and Infrared Sensing System to locate itself and stabilize. When the GPS signal is strong, the aircraft uses GPS to locate itself and stabilize. When the GPS signal is weak and the lighting conditions are sufficient, the aircraft uses vision systems to locate itself and stabilize. When the Forward, Backward, and Downward Vision Systems are enabled and lighting conditions are sufficient, the maximum flight tilt angle is 20° and the maximum flight speed is 12 m/s.

Sport Mode: In Sport Mode, the aircraft uses GPS for positioning and the aircraft responses are optimized for agility and speed making it more responsive to control stick movements. The maximum flight speed is 19 m/s. Obstacle sensing is disabled in Sport mode.

Tripod Mode: Tripod mode is based on Normal mode and the flight speed is limited, making the aircraft more stable during shooting.

The aircraft automatically changes to Attitude (ATTI) mode when the Vision Systems are unavailable or disabled and when the GPS signal is weak or the compass experiences interference. In ATTI mode, the aircraft may be more easily affected by its surroundings. Environmental factors such as wind can result in horizontal shifting, which may present hazards, especially when flying in confined spaces.



- The Forward and Backward Vision Systems are disabled in Sport mode, which means the aircraft cannot sense obstacles on its route automatically.
- The maximum speed and braking distance of the aircraft significantly increase in Sport mode. A minimum braking distance of 30 m is required in windless conditions.
- Descent speed significantly increases in Sport mode. A minimum braking distance of 10 m is required in windless conditions.
- The aircraft's responsiveness significantly increases in Sport mode, which means a small control stick movement on the remote controller translates into the aircraft moving a large distance. Make sure to maintain adequate maneuvering space during flight.

Aircraft Status Indicators



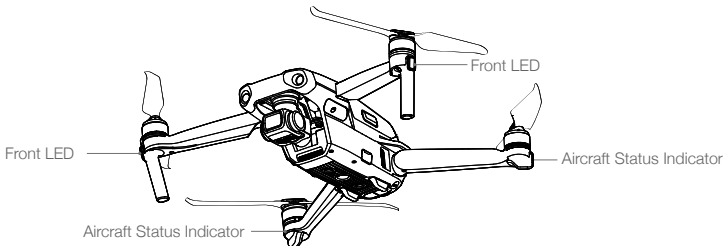









Mavic Air 2 has front LEDs and aircraft status indicators.



The front LEDs show the orientation of the aircraft and glow solid red when the aircraft is turned on to indicate the front of the aircraft.



The aircraft status indicators communicate the status of the aircraft's flight control system. Refer to the table below for more information about the aircraft status indicators.

Aircraft Status Indicator States



	Color	Action	Aircraft Status
Normal States			
	Alternating red, green, and yellow	Blinks	Turning on and performing self-diagnostic tests
	Yellow	Blinks four times	Warming up
	Green	Blinks slowly	With GPS
	Green	Periodically blinks twice	With Forward and Downward Vision Systems
	Yellow	Blinks slowly	No GPS, Forward Vision System or Downward Vision System
	Green	Blinks quickly	Braking
Warning States			
	Yellow	Blinks quickly	Remote controller signal lost
	Red	Blinks slowly	Low battery
	Red	Blinks quickly	Critically low battery
	Red	Blinks	IMU error
	Red	Solid	Critical error
	Alternating red and yellow	Blinks quickly	Compass calibration required

Return to Home

The Return to Home (RTH) function brings the aircraft back to the last recorded Home Point when the GPS is signal is strong. There are three types of RTH: Smart RTH, Low Battery RTH, and Failsafe RTH. This section describes these three types of RTH in detail. If the video link signal is lost during flight while the remote controller is still able to control the movements of the aircraft, there will be a prompt to initiate RTH. RTH can be cancelled.

	GPS	Description
Home Point		The default Home point is the first location where the aircraft received a strong or moderately strong GPS signal (where the icon shows white). The aircraft status indicator blinks green quickly after the home point has been recorded.

Smart RTH

If the GPS signal is sufficient, Smart RTH can be used to bring the aircraft back to the Home Point. Smart RTH is initiated either by tapping  in DJI Fly or by pressing and holding the RTH button on the remote controller until it beeps. Exit Smart RTH by tapping  in DJI Fly or by pressing the RTH button on the remote controller.

Smart RTH includes Straight Line RTH and Power Saving RTH (Return to Home and Land).

Straight Line RTH Procedure:

1. The Home Point is recorded.
2. Smart RTH is triggered.
3.
 - a. If the aircraft is further than 50 m from the Home Point when the RTH procedure begins, the aircraft adjusts its orientation and ascends to the preset RTH altitude and flies to the Home Point. If the current altitude is higher than the RTH altitude, the aircraft flies to the Home Point at the current altitude.
 - b. If the aircraft is at a distance of 5 m to 50 m from the Home Point when the RTH procedure begins, the aircraft adjusts its orientation and flies to the Home Point at the current altitude.
 - c. If the aircraft is less than 5 m from the Home Point when the RTH procedure begins, it lands immediately.
4. After reaching the Home Point, the aircraft lands and the motors stop.



- If the RTH is triggered through DJI Fly and the aircraft is further than 5 m from the Home Point, a prompt will appear in the app for users to select a landing option.

Power Saving RTH (Return to Home and Land) Procedure:

During Straight Line RTH, if the distance is farther than 400 m and the altitude is more than 90 m higher than the RTH altitude as well as more than 290 m higher than the home point, a prompt appears in DJI Fly asking the user if they wish to enter Return to Home and Land in order to save power. After selecting Return to Home and Land, the aircraft calculates the best angle (16.7° horizontally) and flies to the home point. When the aircraft reaches 200 m above the home point or RTH altitude, it lands and the motors stop.

The aircraft exits from Return to Home and Land and enter Straight Line RTH in the following scenarios: 1. if the pitch stick is pulled backward. 2. if the remote controller signal is lost. 3. if the Vision Systems become unavailable.

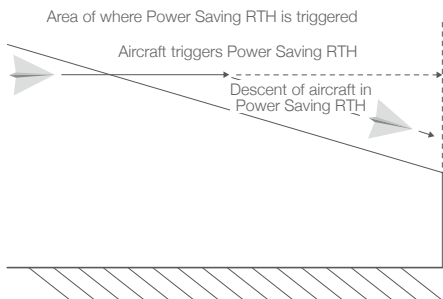

Low Battery RTH

Low Battery RTH is triggered when the Intelligent Flight Battery is depleted to the point that the safe return of the aircraft may be affected. Return home or land the aircraft immediately when prompted.

DJI Fly displays a warning when the battery level is low. The aircraft will automatically return to the Home Point if no action is taken after a 10 second countdown.

The user can cancel RTH by pressing the RTH button or Flight Pause button on the remote controller. If RTH is cancelled following a low battery level warning, the Intelligent Flight Battery may not have enough power for the aircraft to land safely, which may lead to the aircraft crashing or being lost.

The aircraft will land automatically if the current battery level can only support the aircraft long enough to descend from its current altitude. Auto landing cannot be canceled but the remote controller can be used to alter the direction of the aircraft during the landing process.

Failsafe RTH

If the Home Point was successfully recorded and the compass is functioning normally, Failsafe RTH automatically activates after the remote controller signal is lost for more than 11 seconds. The aircraft will fly backwards for 50 m on its original flight route, and then enter Straight Line RTH. The aircraft enters Straight Line RTH if the remote controller signal is restored during Failsafe RTH.

After flying for 50 m:

1. If the aircraft is less than 50 m from the Home Point, it flies back to the Home Point at the current altitude.
2. If the aircraft is further than 50 m from the Home Point and the current altitude is higher than the preset RTH altitude, it flies back to the Home Point at the current altitude.
3. If the aircraft is further than 50 m from the Home Point and the current altitude is lower than the preset RTH altitude, it ascends to the preset RTH altitude and then flies back to the Home Point.

Obstacle Avoidance During RTH

When aircraft is ascending:

1. The aircraft brakes when an obstacle is sensed from in front and flies backward until a safe distance is reached before continuing to ascend.
2. The aircraft brakes when an obstacle is sensed from behind and flies forward until a safe distance is reached before continuing to ascend.
3. No operation will occur when an obstacle is sensed below the aircraft.

When aircraft is flying forward:

1. The aircraft brakes when an obstacle is sensed from in front and flies backward to a safe distance. It ascends until no obstacle is sensed and continues to ascend another 5 m and then continues to fly forward.
2. No operation will occur when an obstacle is sensed from behind.
3. The aircraft brakes when an obstacle is sensed from below and ascends until no obstacle is sensed before flying forward.



- During RTH, obstacles on either side of and above the aircraft cannot be detected or avoided.
 - When ascending in RTH, the aircraft will stop ascending if the throttle stick is pulled all the way down. If the throttle stick is held down for more than 10 seconds or the stick is recentered, the aircraft will exit from RTH.
 - When flying forward in RTH, the aircraft will brake and hover in place if the throttle stick is pulled all the way down. If the throttle stick is held down for more than 10 seconds or the stick is recentered, the aircraft will exit from RTH.
-



- The aircraft cannot return to the Home Point normally if the GPS signal is weak or unavailable. The aircraft will enter ATTI mode if the GPS signal becomes weak or unavailable after RTH is initiated. The aircraft will hover in place for a while before landing.
- It is important to set a suitable RTH altitude before each flight. Launch DJI Fly, and set the RTH altitude. The minimum RTH altitude is 2 m.
- The aircraft cannot avoid obstacles during Failsafe RTH if the Forward and Backward Vision Systems are unavailable.
- During RTH, the speed and altitude of the aircraft can be controlled using the remote controller or DJI Fly if the remote controller signal is normal. The orientation of the aircraft and the direction of flight, however, cannot be controlled. The aircraft cannot avoid obstacles if users push the pitch stick to accelerate and exceed a flight speed of 12 m/s.
- If the aircraft flies into a GEO zone during RTH it will either descend until it exits the GEO zone and continue to the Home Point or it will hover in place.
- The aircraft may not be able to return to a Home Point when the wind speed is too high. Fly with caution.

Landing Protection

Landing Protection will activate during Smart RTH.

1. During Landing Protection, the aircraft will automatically detect and carefully land on suitable ground.
2. If the ground is determined unsuitable for landing, Mavic Air 2 will hover and wait for pilot confirmation.
3. If Landing Protection is not operational, DJI Fly will display a landing prompt when the aircraft descends below 0.5 m. Pull down on the throttle stick or use the auto landing slider to land.

Landing Protection activates during Low Battery RTH and Failsafe RTH. The aircraft performs as follows: During Low Battery RTH and Failsafe RTH, the aircraft hovers at 2 m above the ground and waits for the pilot to confirm it is suitable to land. Pull down on the throttle for one second or use the auto landing slider in the app to land. Landing Protection activates and the aircraft performs the steps listed above.



- Vision Systems are disabled during landing. Make sure to land the aircraft with caution.

Precision Landing

The aircraft automatically scans and attempts to match the terrain features below during RTH. When the current terrain matches the Home Point terrain, the aircraft will land. A prompt will appear in DJI Fly if the terrain match fails.



- Landing Protection is activated during Precision Landing.
- The Precision Landing performance is subject to the following conditions:
 - a. The Home Point must be recorded upon takeoff and must not be changed during flight. Otherwise, the aircraft will have no record of the Home Point terrain features.
 - b. During takeoff, the aircraft must ascend vertically 7 m before moving horizontally.
 - c. The Home Point terrain features must remain largely unchanged.
 - d. The Home Point terrain features must be sufficiently distinctive.
 - e. The lighting conditions must not be too light or too dark.
- The following actions are available during Precision Landing:
 - a. Press the throttle stick down to accelerate landing.
 - b. Move the control sticks in any direction to stop Precision Landing. The aircraft will descend vertically after the control sticks are released.

Vision Systems and Infrared Sensing System

Mavic Air 2 is equipped with both an Infrared Sensing System and Forward, Backward, and Downward Vision Systems.

The Forward, Backward, and Downward Vision Systems consist of two cameras each and the Infrared Sensing System consists of two 3D infrared modules.

The Downward Vision System and Infrared Sensing System helps the aircraft maintain its current position, hover in place more precisely, and to fly indoors or in other environments where GPS is unavailable.

In addition, the Auxiliary Bottom Light located on the underside of the aircraft improves visibility for the Downward Vision System in weak light conditions.

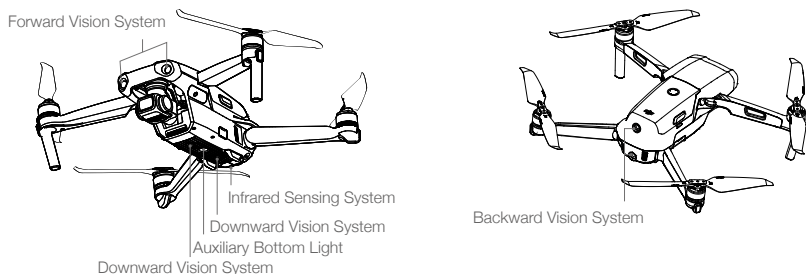

Detection Range

Forward Vision System: Detection Range: 0.35-22 m; FOV: 71° (horizontal), 56° (vertical)

Backward Vision System: Detection Range: 0.37-23.6 m; FOV: 57° (horizontal), 44° (vertical)

Downward Vision System: The Downward Vision System works best when the aircraft is at an altitude of 0.5 to 30 m, and its operating range is 0.5 to 60 m.

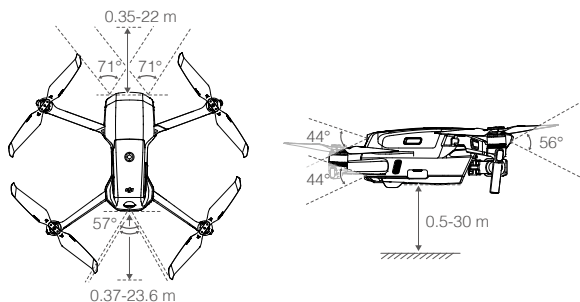

Calibrating Vision System Cameras

Auto Calibration

The Vision System cameras installed on the aircraft are factory calibrated. If any abnormality is detected with a vision system camera, the aircraft will automatically perform calibration and a prompt will appear in DJI Fly. No further operation is required.

Advanced Calibration

If the abnormality persists after auto calibration, a prompt appears in the app that advanced calibration is required. The advanced calibration must be used with DJI Assistant 2 for Mavic. Follow the steps below to calibrate the Forward Vision System cameras, then repeat the steps to calibrate other Vision System cameras.

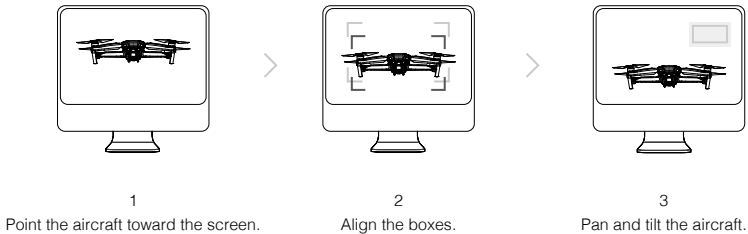

Using the Vision Systems

When GPS is unavailable, the Downward Vision System is enabled if the surface has a clear texture and sufficient light. The Downward Vision System works best when the aircraft is at an altitude of 0.5 to 30 m. If the altitude of the aircraft is above 30 m, the Vision System may be affected, so extra caution is required.

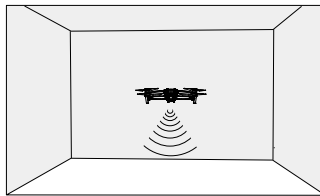

Follow the steps below to use the Downward Vision System:

1. Make sure the aircraft is in Normal or Tripod mode. Power on the aircraft.
2. The aircraft hovers in place after takeoff. The aircraft status indicator blinks green twice, which indicates the Downward Vision System is working.

If the aircraft is in Normal or Tripod mode and Obstacle Detection is enabled in DJI Fly, the Forward and Backward Vision Systems will activate automatically when the aircraft is powered on. Using the Forward and Backward Vision Systems, the aircraft can actively brake when detecting obstacles. The Forward and Backward Vision Systems work best with adequate lighting and clearly marked or textured obstacles.



- The Vision Systems cannot work properly over surfaces that do not have clear pattern variations. The Vision Systems cannot work properly in any of the following situations. Operate the aircraft cautiously.
 - a. Flying over monochrome surfaces (e.g., pure black, pure white, pure green).
 - b. Flying over highly reflective surfaces.
 - c. Flying over water or transparent surfaces.
 - d. Flying over moving surfaces or objects.
 - e. Flying in an area where the lighting changes frequently or drastically.
 - f. Flying over extremely dark (< 10 lux) or bright (> 40,000 lux) surfaces.
 - g. Flying over surfaces that strongly reflect or absorb infrared waves (e.g., mirrors).
 - h. Flying over surfaces without clear patterns or texture. (e.g., power pole).



- i. Flying over surfaces with repeating identical patterns or textures (e.g., tiles with the same design).
 - J. Flying over obstacles with small surface areas (e.g., tree branches).
- Keep the sensors clean at all times. DO NOT tamper with the sensors. DO NOT use the aircraft in dusty or humid environments.
 - If the aircraft experiences a collision, camera calibration is required. Calibrate the cameras if DJI Fly prompts you to do so.
 - DO NOT fly on days that are rainy, smoggy, or if there is no clear sight.
 - Check the following before each takeoff:
 - a. Make sure there are no stickers or any other obstructions over the Infrared Sensing and Vision Systems.
 - b. If there is any dirt, dust, or water on the Infrared Sensing and Vision Systems, clean it with a soft cloth. Do not use any cleanser that contains alcohol.
 - c. Contact DJI Support if there is any damage to the glass of the Infrared Sensing and Vision Systems.
 - DO NOT obstruct the Infrared Sensing System.
-

Intelligent Flight Mode

FocusTrack

FocusTrack includes Spotlight 2.0, Active Track 3.0, and Point of Interest 3.0.

Spotlight 2.0: Fly freely while the camera remains locked on the subject with this convenient mode. Move the roll stick to circle the subject, move the pitch stick to alter the distance from the subject, move the throttle stick to change the altitude, and move the pan stick to adjust the frame.

ActiveTrack 3.0: There are two modes of ActiveTrack 3.0. Move the roll stick to circle the subject, move the pitch stick to alter the distance from the subject, move the throttle stick to change the altitude, and move the pan stick to adjust the frame.

1. Trace: The aircraft tracks the subject at a constant distance. In Normal and Tripod mode, the maximum flight speed is 8 m/s. Note that the aircraft can sense and avoid obstacles in this mode when there are pitch stick movements. The aircraft cannot avoid obstacles when there are roll and throttle sticks movements. In Sport mode, the maximum flight speed is 19 m/s and the aircraft cannot sense obstacles.
2. Parallel: The aircraft tracks the subject at a constant angle and distance from the side. In Normal and Tripod mode, the maximum flight speed is 12 m/s. In Sport mode, the maximum flight speed is 19 m/s. The aircraft cannot sense obstacles in Parallel.

Point of Interest 3.0 (POI 3.0): The aircraft tracks the subject in a circle based on the radius and flight speed that is set. The mode supports both static and moving subjects. Note that if the subject is moving too fast it may be unable to track and the flight altitude is fixed during tracking.

Using FocusTrack

1. Take off and hover at least 3.3 ft (1 m) above the ground.

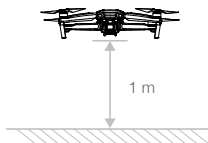

2. Drag a box around the subject in the camera view to enable FocusTrack.



3. FocusTrack begins. The default mode is Spotlight. Tap the icon to switch between Spotlight, ActiveTrack [•], and POI (Q). Once the switch to recognize subjects is enabled, ActiveTrack will begin when a wave gesture is detected (wave with a single hand and the elbow higher than the shoulder).
4. Tap the shutter/record button to take photos or start recording. View the footage in Playback.

Exiting FocusTrack

Tap Stop in DJI Fly or press the Flight Pause button once on the remote controller to exit FocusTrack.



- DO NOT use FocusTrack in areas with people, animals, small or fine objects (e.g., tree branches or power lines), or transparent objects (e.g., water or glass).
- Pay attention to objects around the aircraft and use the remote controller to avoid collisions with the aircraft.
- Operate the aircraft manually. Press the Flight Pause button or tap stop in DJI Fly in an emergency.
- Be extra vigilant when using FocusTrack in any of the following situations:
 - a. The tracked subject is not moving on a level plane.
 - b. The tracked subject changes shape drastically while moving.
 - c. The tracked subject is out of sight for an extended period.
 - d. The tracked subject is moving on a snowy surface.
 - e. The tracked subject has a similar color or pattern to its surrounding environment.
 - f. The lighting is extremely low (<300 lux) or high (>10,000 lux).
- Make sure to follow local privacy laws and regulations when using FocusTrack.
- It is recommended to only track vehicles, boats, and people (but not children). Fly with caution when tracking other subjects.
- Do not track a remote control model car or boat.
- The tracking subject may inadvertently swap to another subject if they pass nearby to each other.
- When using gesture to activate ActiveTrack, the aircraft only tracks the people who perform the first detected gesture. The distance between the people and aircraft should be 5-10 m and the aircraft's tilt angle should not exceed 60°.

QuickShots

QuickShots shooting modes include Dronie, Rocket, Circle, Helix, Boomerang, and Asteroid. Mavic Air 2 records according to the selected shooting mode and automatically generates a short video. The video can be viewed, edited, or shared to social media from playback.



Dronie: The aircraft flies backward and ascends, with the camera locked on the subject.



Rocket: The aircraft ascends with the camera pointing downward.



Circle: The aircraft circles around the subject.



Helix: The aircraft ascends and spirals around the subject.



Boomerang: The aircraft flies around the subject in an oval path, ascending as it flies away from its starting point and descending as it flies back. The aircraft's starting point forms one end of the oval's long axis, while the other end of its long axis is at the opposite side of the subject from the starting point. Make sure there is sufficient space when using Boomerang. Allow a radius of at least 99 ft (30 m) around the aircraft and allow at least 33 ft (10 m) above the aircraft.



Asteroid: The aircraft flies backward and upward, takes several photos, and then flies back to the starting point. The video generated starts with a panorama of the highest position and then shows the descent. Make sure there is sufficient space when using Asteroid. Allow at least 132 ft (40 m) behind and 164 ft (50 m) above the aircraft.

Using QuickShots

1. Take off and hover at least 6.6 ft (2 m) above the ground.

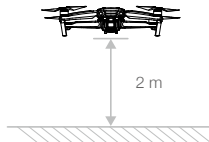

2. In DJI Fly, tap the shooting mode icon to select QuickShots and follow the prompts. Make sure that you understand how to use the shooting mode and that there are no obstacles in the surrounding area.



3. Select your target subject in the camera view by tapping the circle on the subject or dragging a box around the subject. Choose a shooting mode and tap Start to begin recording. When a wave gesture is detected (wave with a single hand and the elbow higher than the shoulder), QuickShots will also be triggered. The aircraft flies back to its original position once shooting is finished.
4. Tap  to access the video.

Exiting QuickShots

Press the Flight Pause/RTH button once or tap  in DJI Fly to exit QuickShots. The aircraft will hover in place.



- Use QuickShots at locations that are clear of buildings and other obstacles. Make sure that there are no humans, animals, or other obstacles on the flight path. APAS is disabled during QuickShots. The aircraft will brake and hover in place when an obstacle is detected in front or behind. Note that obstacles cannot be detected on either side of the aircraft.
- Pay attention to objects around the aircraft and use the remote controller to avoid collisions with the aircraft.
- DO NOT use QuickShots in any of the following situations:
 - a. When the subject is blocked for an extended period or outside the line of sight.
 - b. When the subject is more than 50 m away from the aircraft.
 - c. When the subject is similar in color or pattern with the surroundings.
 - d. When the subject is in the air.
 - e. When the subject moves fast.
 - f. The lighting is extremely low (<300 lux) or high (>10,000 lux).
- DO NOT use QuickShots in places that are close to buildings or where the GPS signal is weak. Otherwise, the flight path will be unstable.
- Make sure to follow local privacy laws and regulations when using QuickShots.
- When using a gesture to activate QuickShots, the aircraft will only track the people who perform the first detected gesture. The distance between the people and aircraft should be 5-10 m and the aircraft's tilt angle should not exceed 60°.

Hyperlapse

Hyperlapse shooting modes include Free, Circle, Course Lock, and Waypoint.

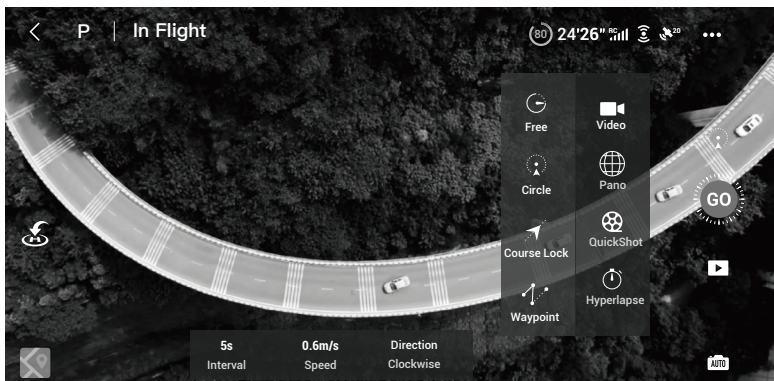

Free

The aircraft automatically takes photos and generates a timelapse video. Free mode can be used while the aircraft is on the ground. After takeoff, control the aircraft's movements and gimbal angle using the remote controller. Follow the steps below to use Free:

1. Set the interval time, video duration, and max speed. The screen displays the number of photos that will be taken and how long the shooting time will be.
2. Tap the shutter button to begin.

Cruise Control: Set the function of the Customizable button to Cruise Control and press the Customizable button and control stick at the same time to enter Cruise Control. The aircraft will continue to fly at the same speed.

Circle

The aircraft automatically takes photos while flying around the selected subject to generate a timelapse video. Follow the steps below to use Circle:

1. Set the interval time, video duration, and max speed. Circle can be selected to travel in either a clockwise or counter-clockwise direction. The screen displays the number of photos that will be taken and how long the shooting time will be.
2. Select a subject on the screen.
3. Tap the shutter button to begin.
4. Move the pan stick and gimbal dial to adjust the frame, move the tilt stick to alter the distance from the subject, move the roll stick to control the circled speed, and move the throttle stick to control the vertical flight speed.

Course Lock

Course Lock can be used in two ways. In the first way, the orientation of the aircraft is fixed, but a subject cannot be selected. In the second way, the orientation of the aircraft is fixed and the aircraft flies around a selected object. Follow the steps below to use Course Lock:

1. Set the interval time, video duration, and max speed. The screen displays the number of photos that will be taken and how long the shooting time will be.
2. Set a flight direction.
3. If applicable, select a subject. Use the gimbal dial and pan stick to adjust the frame.
4. Tap the shutter button to begin. Move the tilt stick and roll stick to control the horizontal flight speed and move the aircraft parallel. Move the throttle stick to control the vertical flight speed.

Waypoints

The aircraft automatically takes photos on a flight path of two to five waypoints and generates a timelapse video. The aircraft can fly in order from waypoint 1 to 5 or 5 to 1. Follow the steps below to use Waypoints.

1. Set the desired waypoints and the lens direction.
2. Set the interval time, video duration, and max speed. The screen displays the number of photos that will be taken and how long the shooting time will be.
3. Tap the shutter button to begin.



- For optimal performance, it is recommended to use Hyperlapse at an altitude higher than 50 m and to set a difference of at least two seconds between the interval time and shutter.
 - It is recommended to select a static subject (e.g., high-rise buildings, mountainous terrain) at a safe distance from the aircraft (further than 15 m). Do not select a subject that is too near the aircraft.
 - The aircraft will brake and hover in place when an obstacle is detected in front or behind during Hyperlapse. Note that obstacles cannot be detected on either side of the aircraft.
-



- The aircraft only generates a video if it has taken at least 25 photos, which is the amount required to generate a one second video. The video generates when a command is given from the remote controller or if the mode is exited unexpectedly (such as when Low Battery RTH is triggered).

The aircraft will generate a timelapse video automatically, which is viewable in playback. In the camera settings, users can select to save the footage in JPEG or RAW format and to store the footage in the built-in storage or the microSD card.

Advanced Pilot Assistance Systems 3.0

The Advanced Pilot Assistance Systems 3.0 (APAS 3.0) feature is available in Normal mode. When APAS is enabled, the aircraft continues to respond to user commands and plans its path according to both control stick inputs and the flight environment. APAS makes it easier to avoid obstacles, obtain smoother footage, and gives a better flying experience.

Keep moving the pitch stick forward or backward. The aircraft will avoid the obstacles by flying above, below, or to the left or right of the obstacle. The aircraft will also respond to other control sticks movements simultaneously.

When APAS is enabled, the aircraft can be brought to a stop by pressing the Flight Pause button on the remote controller or tapping Stop on the screen in DJI Fly. The aircraft hovers for three seconds and awaits further pilot commands.

To enable APAS, open DJI Fly, enter System Settings>Safety, and enable APAS.





- APAS is disabled when using Intelligent Flight modes and recording at high resolution such as 2.7K 48/50/60 fps, 1080p 48/50/60/120/240 fps, and 4K 48/50/60 fps.
- APAS is only available when flying forward and backward. If the aircraft flies left or right, APAS is disabled.
- Make sure you use APAS when the Forward and Backward Vision Systems are available. Be sure there are no people, animals, objects with small surface areas (e.g., tree branches), or transparent objects (e.g., glass or water) along the desired flight path.
- Make sure you use APAS when the Downward Vision System is available or the GPS signal is strong. APAS may not function properly when the aircraft is flying over water or snow-covered area.
- Be extra cautious when flying in extremely dark (<300 lux) or bright (>10,000 lux) environments.
- Pay attention to DJI Fly and ensure the aircraft is working in APAS mode normally.

Flight Recorder

Flight data including flight telemetry, aircraft status information, and other parameters are automatically saved to the internal data recorder of the aircraft. The data can be accessed using DJI Assistant 2 for Mavic.

Propellers

There are two types of Mavic Air 2 Low-Noise Quick Release Propellers, which are designed to spin in different directions. Marks are used to indicate which propellers should be attached to which motors. Make sure to match the propeller and motor following the instructions.

Propellers	Marked	Unmarked
Illustration		
Position	Attach on motors with white marks	Attach on motors without white marks

Attaching the Propellers

Attach the propellers with marks to the motors with marks and the unmarked propellers to the motors without marks. Press each propeller down onto the motor and turn until it is secure.

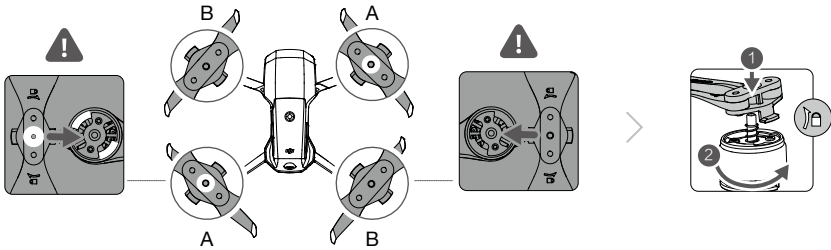

Detaching the Propellers

Press the propellers down onto the motors and rotate them in the unlock direction.

- ⚠ Propeller blades are sharp. Handle with care.
- Only use official DJI propellers. DO NOT mix propeller types.
- Purchase the propellers separately if necessary.
- Make sure that the propellers are installed securely before each flight.
- Make sure all propellers are in good condition before each flight. DO NOT use aged, chipped, or broken propellers.
- Stay away from the rotating propellers and motors to avoid injuries.
- Do not squeeze or bend the propellers during transportation or storage.
- Make sure the motors are mounted securely and rotating smoothly. Land the aircraft immediately if a motor is stuck and unable to rotate freely.
- DO NOT attempt to modify the structure of the motors.
- DO NOT touch or let your hands or body come in contact with the motors after flight as they may be hot.
- DO NOT block any of the ventilation holes on the motors or the body of the aircraft.
- Make sure the ESCs sound normal when powered on.

Intelligent Flight Battery

The Mavic Air 2 Intelligent Flight Battery is a 11.55 V, 3500 mAh battery with smart charging and discharging functionality.

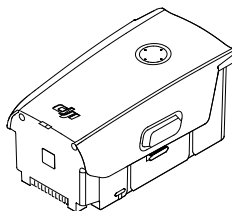

Battery Features

1. **Battery Level Display:** The LED indicators display the current battery level.
2. **Auto-Discharging Function:** To prevent swelling, the battery automatically discharges to 96% of the battery level when it is idle for one day, and automatically discharges to 60% of the battery level when it is idle for five days. It is normal to feel moderate heat being emitted from the battery during the discharging process.
3. **Balanced Charging:** During charging, the voltages of the battery cells are automatically balanced.
4. **Overcharge Protection:** The battery stops charging automatically once fully charged.
5. **Temperature Detection:** In order to protect itself, the battery only charges when the temperature is between 41° and 104° F (5°and 40° C).
6. **Overcurrent Protection:** The battery stops charging if an excess current is detected.
7. **Over-Discharge Protection:** Discharging stops automatically to prevent excess discharge when the battery is not in use. Over-Discharge protection is not enabled when the battery is in use.
8. **Short Circuit Protection:** The power supply is automatically cut if a short circuit is detected.
9. **Battery Cell Damage Protection:** DJI Fly displays a warning prompt when a damaged battery cell is detected.
10. **Hibernation Mode:** The battery switches off after 20 minutes of inactivity to save power. If the battery level is less than 5%, the battery enters Hibernation mode to prevent over-discharge after being idle for six hours. In Hibernation mode, the battery level indicators do not illuminate. Charge the battery to wake it from hibernation.
11. **Communication:** Information about the battery's voltage, capacity, and current is transmitted to the aircraft.



- Refer to the Mavic Air 2 Disclaimer and Safety Guidelines and the battery sticker before use. Users take full responsibility for all operations and usage.

Using the Battery

Checking Battery Level

Press the power button once to check the battery level.

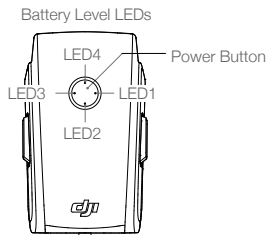

Battery Level LEDs

○ : LED is on ◉ : LED is flashing ○ : LED is off

LED1	LED2	LED3	LED4	Battery Level
○	○	○	○	Battery Level ≥ 88%
○	○	○	◉	75% ≤ Battery Level < 88%
○	○	○	○	63% ≤ Battery Level < 75%
○	○	◉	○	50% ≤ Battery Level < 63%
○	○	○	○	38% ≤ Battery Level < 50%
○	◉	○	○	25% ≤ Battery Level < 38%
○	○	○	○	13% ≤ Battery Level < 25%
◉	○	○	○	0% ≤ Battery Level < 13%

Powering On/Off

Press the power button once, then press again, and hold for two seconds to power the battery on or off. The battery level LEDs display the battery level when the aircraft is powered on.

Low Temperature Notice

1. Battery capacity is significantly reduced when flying in low-temperature environments of 14° to 41° F (-10° to 5° C). It is recommended to hover the aircraft in place for a while to heat the battery. Make sure to fully charge the battery before takeoff.
2. Batteries cannot be used in extremely low-temperature environments of lower than 14° F (-10° C).
3. When in low-temperature environments, end the flight as soon as DJI Fly displays the low battery level warning.
4. To ensure the optimal performance of the battery, keep the battery temperature above 68° F (20° C).
5. The reduced battery capacity in low-temperature environments reduces the wind speed resistance performance of the aircraft. Fly with caution.
6. Fly with extra caution at high sea levels.

Charging the Battery

Fully charge the Intelligent Flight Battery before every flight using the provided DJI charger.

1. Connect the AC power adapter to an AC power supply (100-240 V, 50/60 Hz).
2. Attach the Intelligent Flight Battery to the AC power adapter using the battery charging cable with the battery powered off.
3. The battery level LEDs display the current battery level during charging.
4. The Intelligent Flight Battery is fully charged when all the battery level LEDs are off. Detach the charger when the battery is fully charged.



-
- ⚠️ • DO NOT charge an Intelligent Flight Battery immediately after flight as the temperature may be too high. Wait until it cools down to room temperature before charging again.
 - The charger stops charging the battery if the battery cell temperature is not within the operating range of 41° to 104° F (5° to 40° C). The ideal charging temperature is 71.6° to 82.4° F (22° to 28° C).
 - The Battery Charging Hub (not included) can charge up to three batteries. Visit the official DJI Online Store to learn more.
 - Fully charge the battery at least once every three months to maintain battery health.
 - DJI does not take any responsibility for damage caused by third-party chargers.

-
- ☀️ • It is recommended to discharge the Intelligent Flight Batteries to 30% or lower before transportation. This can be done by flying the aircraft outdoors until there is less than 30% charge left.
-

The table below shows the battery level during charging.

LED1	LED2	LED3	LED4	Battery Level
☀	☀	○	○	0% < Battery Level ≤ 50%
☀	☀	☀	○	50% < Battery Level ≤ 75%
☀	☀	☀	☀	75% < Battery Level < 100%
○	○	○	○	Fully Charged

Battery Protection Mechanisms

The battery LED indicator can display battery protection indications triggered by abnormal charging conditions.

Battery Protection Mechanisms					
LED1	LED2	LED3	LED4	Blinking Pattern	Status
○	☀	○	○	LED2 blinks twice per second	Overcurrent detected
○	☀	○	○	LED2 blinks three times per second	Short circuit detected
○	○	☀	○	LED3 blinks twice per second	Overcharge detected
○	○	☀	○	LED3 blinks three times per second	Over-voltage charger detected
○	○	○	☀	LED4 blinks twice per second	Charging temperature is too low
○	○	○	☀	LED4 blinks three times per second	Charging temperature is too high

If the battery protection mechanisms activate, in order to resume charging it is necessary to unplug the battery from the charger, and then plug it in again. If the charging temperature is abnormal, wait for the charging temperature to return to normal, and the battery will automatically resume charging without requiring to unplug and plug in the charger again.

Inserting the Intelligent Flight Battery

Insert the Intelligent Flight Battery into the battery compartment of the aircraft. Make sure it is mounted securely and that the battery buckles are clicked into place.

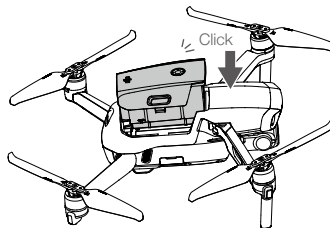

Removing the Intelligent Flight Battery

Press the battery buckles on the sides of the Intelligent Flight Battery to remove it from the compartment.



- DO NOT detach the battery when the aircraft is powering on.
- Make sure that the battery is mounted firmly.

Gimbal and Camera

Gimbal Profile

The 3-axis gimbal of Mavic Air 2 provides stabilization for the camera, allowing you to capture clear and stable images and video. The control pan range is -80° to $+80^{\circ}$ and the control tilt range is -90° to $+24^{\circ}$. The default control tilt range is -90° to 0° , and the tilt range can be extended to -90° to $+24^{\circ}$ by enabling "Allow Upward Gimbal Rotation" in DJI Fly.

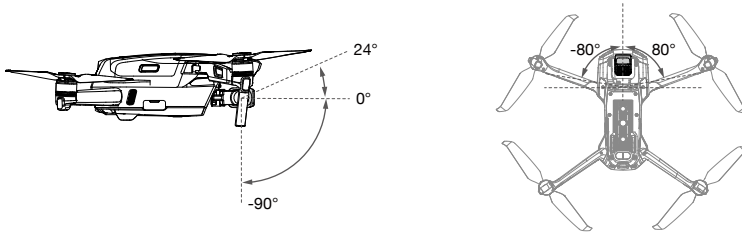

Use the gimbal dial on the remote controller to control the tilt of the camera. Alternatively, enter the camera view in DJI Fly. Press the screen until an adjustment bar appears and drag up and down to control the camera's tilt and drag left and right to control the camera's pan.

Gimbal Operation Modes

Two gimbal operation modes are available. Switch between the different operation modes in DJI Fly.

Follow Mode: The angle between the gimbal's orientation and aircraft front remains constant at all times.

FPV Mode: The gimbal synchronizes with the movement of the aircraft to provide a first-person flying experience.



- When the aircraft is powered on, do not tap or knock the gimbal. To protect the gimbal during takeoff, take off from open and flat ground.
- Precision elements in the gimbal may be damaged in a collision or impact, which may cause the gimbal to function abnormally.
- Avoid getting dust or sand on the gimbal, especially in the gimbal motors.
- A gimbal motor may enter protection mode in the following situations:
 - a. The aircraft is on uneven ground or the gimbal is obstructed.
 - b. The gimbal experiences excessive external force, such as during a collision.
- DO NOT apply external force to the gimbal after the gimbal is powered on. DO NOT add any extra payload to the gimbal as this may cause the gimbal to function abnormally or even lead to permanent motor damage.
- Make sure to remove the gimbal protector before powering on the aircraft. Also, make sure to mount the gimbal protector when the aircraft is not in use.
- Flying in heavy fog or clouds may make the gimbal wet, leading to temporary failure. The gimbal recovers full functionality once it is dry.

Camera Profile

Mavic Air 2 uses a $1/2''$ CMOS sensor camera, which can shoot up to 4K 60 fps video and 48 MP photos, and supports shooting modes such as Single, Burst, AEB, Timed Shot, Panorama, and Slow Motion. The aperture of the camera is $f2.8$ and can shoot at 1 m to infinity.



- Make sure the temperature and humidity is suitable for the camera during usage and storage.
 - Use a lens cleanser to clean the lens to avoid damage.
 - DO NOT block any ventilation holes on the camera as the heat generated may damage the device and hurt the user.
-

Storing Photos and Videos

Mavic Air 2 supports the use of a microSD card to store your photos and videos. A UHS-I Speed Grade 3 rating microSD card is required due to the fast read and write speeds necessary for high-resolution video data. Refer to the Specifications section for more information about recommended microSD cards.



- Do not remove the microSD card from the aircraft while it is powered on. Otherwise, the microSD card may be damaged.
 - To ensure the stability of the camera system, single video recordings are limited to 30 minutes.
 - Check camera settings before use to ensure they are configured as desired.
 - Before shooting important photos or videos, shoot a few images to test the camera is operating correctly.
 - Photos or videos cannot be transmitted or copied from the camera if the aircraft is powered off.
 - Make sure to power off the aircraft correctly. Otherwise, your camera parameters will not be saved and any recorded videos may be damaged. DJI is not responsible for any failure of an image or video to be recorded or having been recorded in a way that is not machine-readable.
-

Remote Controller

This section describes the features of the remote controller and includes instructions for controlling the aircraft and the camera.

Remote Controller

Remote Controller Profile

Built into the remote controller is DJI's long-range transmission technology OcuSync 2.0, offering a maximum transmission range of 6 mi (10 km) and displaying video from the aircraft to DJI Fly on your mobile device at up to 1080p. Control the aircraft and camera smoothly using the onboard buttons while the detachable control sticks make the remote controller easy to store.

In a wide-open area with no electromagnetic interference, OcuSync 2.0 smoothly transmits video links at up to 1080p, no matter how the flight attitude is changed. The remote controller works at both 2.4 GHz and 5.8 GHz, automatically selecting the best transmission channel.

OcuSync 2.0 reduces the latency to 120-130 ms by improving the camera performance through its video decoding algorithm and the wireless link.

The built-in battery has a capacity of 5200 mAh and a maximum run time of 6 hours. The remote controller charges the mobile device with a charging ability of 500 mA@5V. The remote controller automatically charges Android devices. For iOS devices, first make sure that charging is enabled in DJI Fly. Charging for iOS devices is disabled by default and needs to be enabled each time the remote controller is powered on.



- Compliance Version: The remote controller is compliant with local regulations.
- Control Stick Mode: The control stick mode determines the function of each control stick movement. Three pre-programmed modes (Mode 1, Mode 2, and Mode 3) are available and custom modes can be configured in DJI Fly. The default mode is Mode 2.

Using the Remote Controller

Powering On/Off

Press the power button once to check the current battery level. Press once, then again, and hold to power the remote controller on or off. If the battery level is too low, recharge before use.

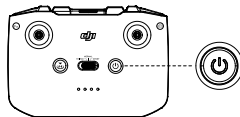

Charging the Battery

Use a USB-C cable to connect an AC power charger to the USB-C port of the remote controller. It takes approximately four hours to fully charge the remote controller.

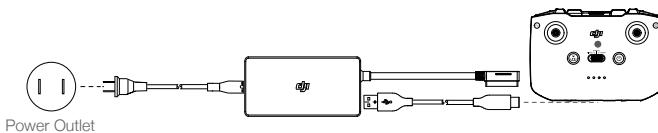

Controlling the Gimbal and Camera

1. Shutter/Record Button: Press once take a photo or to start or stop recording.
2. Photo/Video Toggle: Press once to switch between photo and video mode.
3. Gimbal Dial: Use to control the tilt of the gimbal.

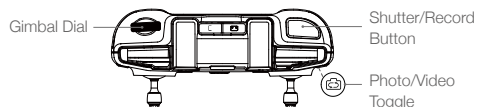

Controlling the Aircraft

The control sticks control the aircraft's orientation (pan), forward/ backward movement (pitch), altitude (throttle), and left/right movement (roll). The control stick mode determines the function of each control stick movement. Three preprogrammed modes (Mode 1, Mode 2, and Mode 3) are available and custom modes can be configured in DJI Fly. The default mode is Mode 2.

Mode 1

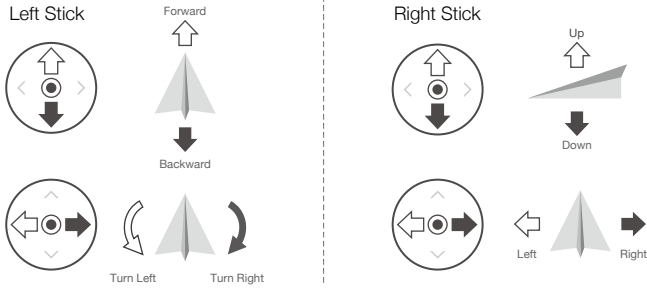



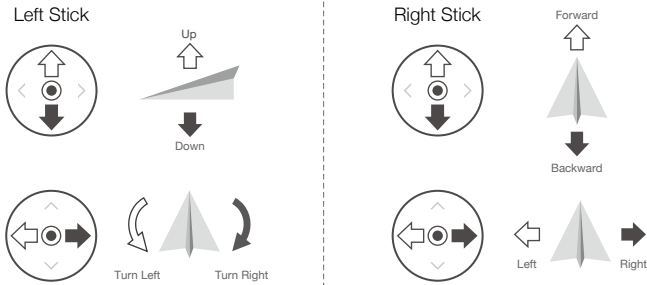

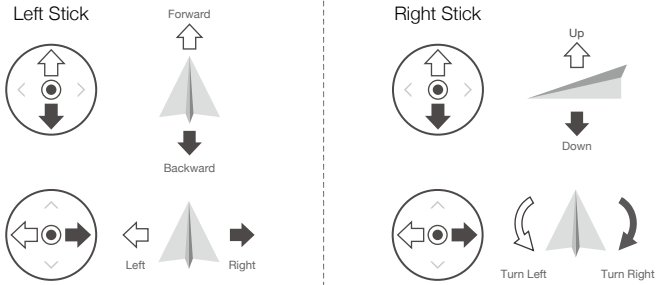

Mode 2

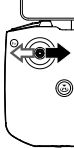
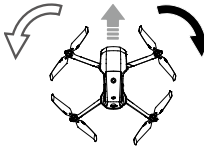

Mode 3



Remote Controller (Mode 2)	Aircraft (← Indicates Nose Direction)	Remarks
		<p>Moving the left stick up or down changes the aircraft's altitude. Push the stick up to ascend and down to descend. The more the stick is pushed away from the center position, the faster the aircraft will change altitude. Always push the stick gently to prevent sudden and unexpected changes in altitude.</p>
		<p>Moving the left stick to the left or right controls the orientation of the aircraft. Push the stick left to rotate the aircraft counter-clockwise and right to rotate the aircraft clockwise. The more the stick is pushed away from the center position, the faster the aircraft will rotate.</p>
		<p>Moving the right stick up and down changes the aircraft's pitch. Push the stick up to fly forward and down to fly backward. The more the stick is pushed away from the center position, the faster the aircraft will move.</p>
		<p>Moving the right stick to the left or right changes the aircraft's roll. Push the stick left to fly left and right to fly right. The more the stick is pushed away from the center position, the faster the aircraft will move.</p>

Flight Mode Switch

Toggle the switch to select the desired flight mode.

Position	Flight Mode
Sport	Sport Mode
Normal	Normal Mode
Tripod	Tripod Mode



Flight Pause/RTH Button

Press once to make the aircraft brake and over in place. If the aircraft is performing QuickShots, RTH, or auto landing, press once to exit the procedure and then brake.

Press and hold the RTH button until the remote controller beeps to start RTH. Press this button again to cancel RTH and regain control of the aircraft. Refer to the Return to Home section for more information about RTH.

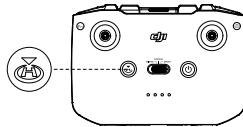

Customizable Button

Go to DJI Fly System Settings, and then select Control to customize the function for this button. Functions include recentering the gimbal, switching the auxiliary LED, and toggling the map and live view.

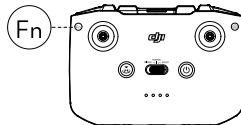

Remote Controller Alert

The remote controller sounds an alert during RTH or when the battery level is low (6% to 10%). The low battery alert level can be cancelled by pressing the power button. The critical battery level alert (less than 5%), however, cannot be cancelled.

Optimal Transmission Zone

The signal between the aircraft and the remote controller is most reliable when the antennas are positioned in relation to the aircraft as depicted below.

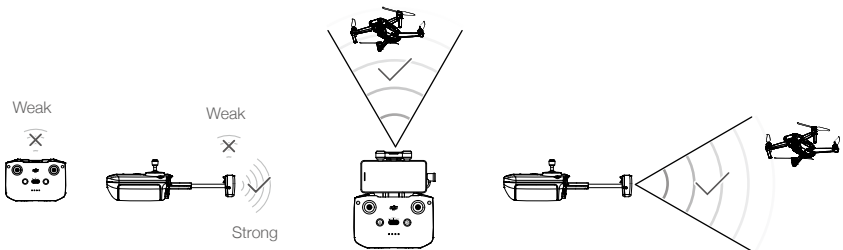

Optimal Transmission Zone

Linking the Remote Controller

The remote controller is linked to the aircraft before delivery. Linking is only required when using a new remote controller for the first time. Follow these steps to link a new remote controller:

1. Power on the remote controller and the aircraft.
2. Launch DJI Fly.
3. In camera view, tap ●●● and select Control and Pair to Aircraft (Link).
4. Press and hold the power button of the aircraft for more than four seconds. The aircraft beeps once indicating it is ready to link. The aircraft beeps twice indicating linking is successful. The battery level LEDs of the remote controller will glow solid.



- Make sure the remote controller is within 0.5 m of the aircraft during linking.
- The remote controller will automatically unlink from an aircraft if a new remote controller is linked to the same aircraft.



- Fully charge the remote controller before each flight. The remote controller sounds an alert when the battery level is low.
 - If the remote controller is powered on and not in use for five minutes, an alert will sound. After 6 minutes, the aircraft automatically powers off. Move the control sticks or press any button to cancel the alert.
 - Adjust the mobile device holder to ensure the mobile device is secure.
 - Fully charge the battery at least once every three months to maintain battery health.
-

DJI Fly App

This section introduces the main functions of the DJI Fly app.

DJI Fly App

Home

Launch DJI Fly and enter the home screen.



Fly Spots

View or share nearby suitable flight and shooting locations, learn more about GEO zones, and preview aerial photos of different locations taken by other users.

Academy

Tap the icon in the top right corner to enter Academy. Product tutorials, flight tips, flight safety, and manual documents can be viewed here.

Album

Allows you to view the DJI Fly and your phone's album. Create contains Templates and Pro. Templates provides auto edit feature for imported footage. Pro allows you to edit the footage manually.

SkyPixel

Enter SkyPixel to view videos and photos shared by users.

Profile

View the account information, flight records, DJI forum, online store, Find My Drone feature, and other settings.

Camera View

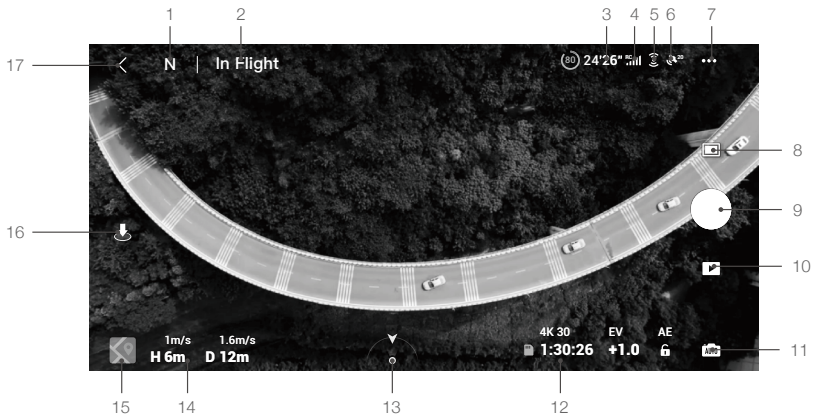

1. Flight Mode

N : Displays the current flight mode.

2. System Status Bar

In Flight : Indicates aircraft flight status and displays various warning messages.

3. Battery Information

24'26" : displays the current battery level and remaining flight time.

4. Video Downlink Signal Strength

BC : Displays the video downlink strength between the aircraft and remote controller.

5. Forward and Backward Vision Systems Status

📷 : The top of the icon indicates the status of the Forward Vision System and the bottom of the icon indicates the status of the Backward Vision System. The icon is white when the vision system is working normally and red when the vision system is unavailable.

6. GPS Status

📶 : Displays the current GPS signal strength.

7. System Settings

••• : Tap to view information about safety, control, and transmission.

Safety

Flight Protection: Tap to set the max altitude, max distance, Auto RTH altitude, and to update the Home Point.

Flight Assistance: The Forward and Downward Vision System are enabled, which means the aircraft can sense and avoid obstacles when Obstacle Detection is enabled. The aircraft cannot avoid obstacles when Obstacle Detection is disabled. APAS is only enabled when it is switched on.

Sensors: Tap to view the IMU and compass status and start to calibrate if necessary. Users can also check the auxiliary LED and unlock GEO zone settings.

Advanced Safety Settings include the behavior settings of the aircraft when the remote controller signal is lost and when the propellers can be stopped during flight. "Emergency Only" indicates that the motors can only be stopped mid-flight in an emergency situation such as if there is a collision, a motor has stalled, the aircraft is rolling in the air, or the aircraft is out of control and is ascending or descending very quickly. "Anytime" indicates that the motors can be stopped mid-flight anytime once user performs a combination

stick command (CSC). Stopping the motors in mid-flight will cause the aircraft to crash.

The Find My Drone feature helps to find the location of the aircraft on the ground.

Control

Aircraft Settings: Tap to set the measurement system.

Gimbal Settings: Tap to set the gimbal mode, allow gimbal rotation, recenter the gimbal, and to calibrate the gimbal.

Remote Controller Settings: Tap to set the function of the customizable button, to calibrate the remote controller, to enable phone charging for the iOS device connected, and to switch stick modes. Make sure to understand the operations of a stick mode before changing stick mode.

Beginner Flight Tutorial: View the flight tutorial.

Connect to Aircraft: When the aircraft is not linked to the remote controller, tap to start linking.

Camera

Camera Parameter Settings: Displays different settings according to the shooting mode.

Shooting Modes	Settings
Photo	Photo Format and Size
Video	Video Format, Color, Coding Format, and Video Subtitles
QuickShots	Video Format, Resolution, and Video Subtitles
Hyperlapse	Video Format, Resolution, Photo Type, Anti-Flicker, and Shot Frame
Pano	Photo Type

General Settings: Tap to view and set histogram, overexposure warning, gridlines, white balance, auto sync HD photos, and cache when recording.

Storage Location: Footage can be stored in the aircraft or on a microSD card.

Cache Settings: Set to cache when recording and the max video cache capacity.

Transmission

Definition, frequency, and channel mode settings.

About

View device information, firmware information, app version, battery version, and more.

8. Shooting Modes

 Photo: Single, 48MP, Smart, AEB, Burst, and Timed Shot.

Video: Normal (4K 24/25/30/48/50/60 fps, 2.7K 24/25/30/48/50/60 fps, 1080p 24/25/30/48/50/60 fps), HDR (4K 24/25/30 fps, 2.7K 24/25/30 fps, 1080p 24/25/30 fps), Slow Motion (1080p 120/240 fps).

Pano: Sphere, 180°, Wide Angle, and Vertical. The aircraft automatically takes several photos according to the selected type of Pano and generates a panoramic shot.

QuickShots: Choose from Dronie, Circle, Helix, Rocket, Boomerang, and Asteroid.

Hyperlapse: Choose from Free, Circle, Course Lock, and Waypoints.

9. Shutter/Record Button

 : Tap to take a photo or to start or stop recording a video.

10. Playback

 : Tap to enter playback and preview photos and videos as soon as they are captured.

11. Camera Modes Switch

 : Choose between Auto and Manual mode when in photo mode. In Manual mode, shutter and ISO can be set. In Auto mode, AE lock and EV can be set.

12. microSD Card Information

 **1:30:26** : displays the remaining number of photos or video recording time of the current microSD card. Tap to view the available capacity of the microSD card.

13. Aircraft Orientation

 : Displays the real-time orientation of the aircraft.

14. Flight Telemetry

D 12m H 6m 1.6m/s 1m/s: Displays the distance between the aircraft and the Home Point, height from the Home Point, aircraft horizontal speed, and aircraft vertical speed.

15. Map

 : Tap to view the map.

16. Auto Takeoff/Landing/RTH

 Tap the icon. When the prompt appears, press and hold the button to initiate auto takeoff or landing.

Tap  to initiate Smart RTH and have the aircraft return to the last recorded Home Point.

17. Back

 : Tap to return to the home screen.

Drag a box around a subject in the camera view to enable FocusTrack. Press and hold on the screen to bring up the gimbal adjustment bar to adjust the gimbal angle.



- Make sure to fully charge your mobile device before launching DJI Fly.
 - Mobile cellular data is required when using DJI Fly. Contact your wireless carrier for data charges.
 - If you are using a mobile phone as your display device, DO NOT accept phone calls or use texting features during flight.
 - Read all safety tips, warning messages, and disclaimers carefully. Familiarize yourself with the related regulations in your area. You are solely responsible for being aware of all relevant regulations and flying in a way that is compliant.
 - a. Read and understand the warning messages before using the Auto-take off and Auto-landing features.
 - b. Read and understand the warning messages and disclaimer before setting the altitude beyond the default limit.
 - c. Read and understand the warning messages and disclaimer before switching between flight modes.
 - d. Read and understand the warning messages and disclaimer prompts near or in GEO zones.
 - e. Read and understand the warning messages before using the Intelligent Flight modes.
 - Land your aircraft immediately at a safe location if a prompt appears in the app.
 - Review all warning messages on the checklist displayed in the app before each flight.
 - Use the in-app tutorial to practice your flight skills if you have never operated the aircraft or if you do not have sufficient experience to operate the aircraft with confidence.
 - Cache the map data of the area where you intend to fly the aircraft by connecting to the internet before each flight.
 - The app is designed to assist your operation. Use your sound discretion and DO NOT rely on the app to control your aircraft. Your use of the app is subject to DJI Fly Terms of Use and DJI Privacy Policy. Read them carefully in the app.
-

Flight

This section describes safe flight practices and flight restrictions.

Flight

Once pre-flight preparation is complete, it is recommended to hone your flight skills and practice flying safely. Make sure that all flights are carried out in an open area. Refer to the Remote Controller and DJI Fly sections for information about using the remote controller and the app to control the aircraft.

Flight Environment Requirements

1. Do not use the aircraft in severe weather conditions including wind speeds exceeding 10 m/s, snow, rain, and fog.
2. Only fly in open areas. Fly in open areas. Tall structures and large metal structures may affect the accuracy of the onboard compass and GPS system. It is recommended to keep the aircraft at least 5 m away from structures.
3. Avoid obstacles, crowds, high voltage power lines, trees, and bodies of water. It is recommended to keep the aircraft at least 3 m above water.
4. Minimize interference by avoiding areas with high levels of electromagnetism such as locations near power lines, base stations, electrical substations, and broadcasting towers.
5. Aircraft and battery performance is subject to environmental factors such as air density and temperature. Be careful when flying 16,404 ft (5,000 m) or more above sea level, since battery and aircraft performance may be reduced.
6. Aircraft cannot use GPS within the polar regions. Use the Downward Vision System when flying in such locations.
7. If taking off from a moving surface, such as a moving boat or vehicle, fly with caution.

Flight Limits and GEO Zones

Unmanned aerial vehicle (UAV) operators should abide by the regulations from self-regulatory organizations such as the International Civil Aviation Organization, the Federal Aviation Administration, and local aviation authorities. For safety reasons, flight limits are enabled by default to help users operate this aircraft safely and legally. Users can set flight limits on height and distance.

Altitude limits, distance limits, and GEO zones function concurrently to manage flight safety when GPS is available. Only altitude can be limited when GPS is unavailable.

Flight Altitude and Distance Limits

The flight altitude and distance limits can be changed in DJI Fly. Based on these settings, the aircraft will fly in a restricted cylinder, as shown below:

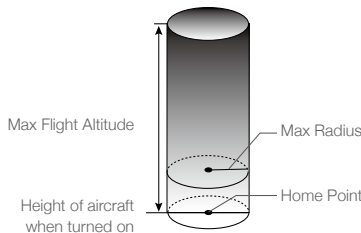

When GPS is available

	Flight Limits	DJI Fly App	Aircraft Status Indicator
Max Altitude	Aircraft's altitude cannot exceed the specified value	Warning: Height limit reached	Blinks green and red alternately
Max Radius	Flight distance must be within the max radius	Warning: Distance limit reached	

Only Downward Vision System is available

	Flight Limits	DJI Fly App	Aircraft Status Indicators
Max Altitude	Height is restricted to 16 ft (5 m) when the GPS signal is weak and Downward Vision System is activated. Height is restricted to 98 ft (30 m) when the GPS signal is weak and Downward Vision System is inactive.	Warning: Height limit reached.	Blinks green and red alternately
Max Radius	Blinks yellow		



- The altitude limit when the GPS is weak will not be restricted if there was a strong GPS signal when the aircraft was powered on.
- If the aircraft is in a GEO zone and there is a weak or no GPS signal, the aircraft status indicator will glow red for five seconds every twelve seconds.
- If the aircraft reaches a limit, you can still control the aircraft, but you cannot fly it any further. If the aircraft flies out of the max radius, it will automatically fly back within range when the GPS signal is strong.
- For safety reasons, do not fly close to airports, highways, railway stations, railway lines, city centers, or other sensitive areas. Fly the aircraft only within your line of sight.

GEO Zones

All GEO zones are listed on the DJI official website at <http://www.dji.com/flysafe>. GEO zones are divided into different categories and include locations such as airports, flying fields where manned aircraft operate at low altitudes, borders between countries, and sensitive locations such as power plants.

There will be prompts in the DJI Fly app to fly in GEO zones.

Pre-Flight Checklist

1. Make sure the remote controller, mobile device, and Intelligent Flight Battery are fully charged.
2. Make sure the Intelligent Flight Battery and the propellers are mounted securely.
3. Make sure the aircraft arms are unfolded.
4. Make sure the gimbal and camera are functioning normally.
5. Make sure that there is nothing obstructing the motors and that they are functioning normally.
6. Make sure that DJI Fly is successfully connected to the aircraft.
7. Make sure that the camera lens and Vision System sensors are clean.
8. Use only genuine DJI parts or parts certified by DJI. Unauthorized parts or parts from non-DJI certified manufacturers may cause system malfunctions and compromise safety.

Auto Takeoff/Landing

Auto Takeoff

Use auto takeoff when the aircraft status indicator blinks green.



1. Launch DJI Fly and enter the camera view.
2. Complete all steps in the pre-flight checklist.
3. Tap . If conditions are safe for takeoff, press and hold the button to confirm.
4. The aircraft will take off and hover 3.9 ft (1.2 m) above the ground.



- The aircraft status indicator indicates whether the aircraft is using GPS and/or the Downward Vision System for flight control. It is recommended to wait until the GPS signal is strong before using auto takeoff.
- DO NOT takeoff from a moving surface, such as a moving boat or vehicle.

Auto Landing

Use auto landing when the aircraft status indicator blinks green.

1. Tap . If conditions are safe to land, press and hold the button to confirm.
2. Auto landing can be cancelled by tapping .
3. If the Vision System is working normally, Landing Protection will be enabled.
4. Motors stops after landing.



- Choose an appropriate place for landing.

Starting/Stopping the Motors

Starting the Motors

A Combination Stick Command (CSC) is used to start the motors. Push both sticks to the bottom inner or outer corners to start the motors. Once the motors have started spinning, release both sticks simultaneously.

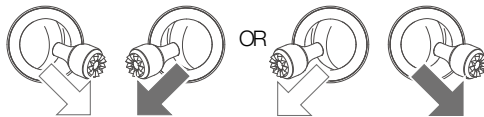

Stopping the Motors

There are two methods to stop the motors.

1. Method 1: When the aircraft has landed, push and hold the left stick down. The motors will stop after three seconds.
2. Method 2: When aircraft has landed, push the left stick down, then conduct the same CSC that was used to start the motors, as described above. The motors will stop immediately. Release both sticks once the motors have stopped.

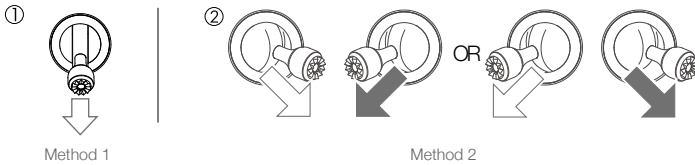

Stopping the Motors Mid-flight

Stopping motors mid-flight will cause the aircraft to crash. The motors should only be stopped mid-flight in an emergency situation such as if a collision has occurred or if the aircraft is out of control and is ascending or descending very quickly, rolling in the air, or if a motor has stalled. To stop the motors mid-flight use the same CSC that was used to start the motors. The default setting can be changed in DJI Fly.

Flight Test

Takeoff/Landing Procedures

1. Place the aircraft in an open, flat area with the aircraft status indicator facing towards you.
2. Turn on the aircraft and the remote controller.
3. Launch DJI Fly and enter the camera view.
4. Wait until the aircraft status indicators blink green indicating that the Home Point has been recorded and it is now safe to fly.
5. Gently push the throttle stick to take off or use auto-takeoff.
6. Pull the throttle stick or use auto-landing to land the aircraft.
7. After landing, push the throttle stick down and hold. The motors stop after three seconds.
8. Turn off the aircraft and remote controller.

Video Suggestions and Tips

1. The pre-flight checklist is designed to help you fly safely and to ensure that you can shoot video during flight. Go through the full pre-flight checklist before each flight.
2. Select the desired gimbal operation mode in DJI Fly.
3. Shoot video when flying in N-mode or T-mode.
4. DO NOT fly in bad weather conditions such as when it is raining or windy.
5. Choose the camera settings that best suit your needs.
6. Perform flight tests to establish flight routes and to preview scenes.
7. Push the control sticks gently to keep the aircraft movement smooth and stable.



- Make sure to place the aircraft on a flat and steady surface before takeoff. DO NOT takeoff from your palm or while holding the aircraft with your hand.

Appendix

Appendix

Specifications

Aircraft	
Takeoff Weight	570 g
Dimensions (LxWxH)	Folded: 180x97x84 mm Unfolded: 183x253x77 mm
Diagonal Distance	302 mm
Max Ascent Speed	4 m/s (S Mode) 4 m/s (N Mode)
Max Descent Speed	3 m/s (S Mode) 3 m/s (N Mode)
Max Speed (near sea level, no wind)	19 m/s (S Mode) 12 m/s (N Mode) 5 m/s (T Mode)
Max Service Ceiling Above Sea Level	5000 m
Max Flight Time	34 mins (measured while flying at 18 kph in windless conditions)
Max Hover Time (without wind)	33 minutes
Max Flight Distance	18.5 km
Max Wind Speed Resistance	10 m/s (Scale 5)
Max Tilt Angle	35° (S Mode) 20° (N Mode)
Max Angular Velocity	250°/s (S Mode) 250°/s (N Mode)
Operating Temperature	14° to 104° F (-10° to 40° C)
GNSS	GPS + GLONASS
Operating Frequency	2.400-2.4835 GHz, 5.725-5.850 GHz
Transmitter Power (EIRP)	2.400 - 2.4835 GHz: ≤26 dBm (FCC), ≤20 dBm (CE), ≤20 dBm (SRRC) , ≤20 dBm (MIC) 5.725 - 5.850 GHz: ≤26 dBm (FCC), ≤14 dBm (CE), ≤26 dBm (SRRC)
Hovering Accuracy Range	Vertical: ±0.1 m (with Vision Positioning), ±0.5 m (with GPS Positioning) Horizontal: ±0.1 m (with Vision Positioning), ±1.5 m (with GPS Positioning)
Internal Storage	8 GB
Gimbal	
Mechanical Range	Tilt: -135° to +45° Roll: -45° to +45° Pan: -100° to +100°
Controllable Range	Tilt: -90° to 0° (default setting) -90° to +24° (extended setting) Pan: -80° to +80°
Stabilization	3-axis (tilt, roll, pan)
Max Control Speed (tilt)	100°/s
Angular Vibration Range	±0.01°

Sensing System	
Forward	Precision Measurement Range: 0.35-22.0 m Detection Range: 0.35-44 m Effective Sensing Speed: ≤ 12 m/s FOV: 71° (horizontal), 56° (vertical)
Backward	Precision Measurement Range: 0.37-23.6 m Detection Range: 0.37-47.2 m Effective Sensing Speed: ≤ 12 m/s FOV: 44° (horizontal), 57° (vertical)
Downward	Infrared Sensor Measurement Range: 0.1-8 m Hovering Range: 0.5-30 m Vision Sensor Hovering Range: 0.5-60 m
Operating Environment	Non-reflective, discernible surfaces with diffuse reflectivity of $>20\%$; Adequate lighting of lux >15
Camera	
Sensor	1/2 CMOS Effective Pixels: 12/48 MP
Lens	FOV: 84° 35 mm Format Equivalent: 24 mm Aperture: f/2.8 Shooting Range: 1 m to ∞
ISO	Video: 100-6400 Photo (12 MP): 100-3200 (Auto) 100-6400 (Manual) Photo (48 MP): 100-1600 (Auto) 100-3200 (Manual)
Electronic Shutter Speed	8-1/8000 s
Max Image Size	48 MP: 8000×6000 12 MP: 4000×3000
Still Photography Modes	Single: 12 MP/48 MP Burst: 12 MP, 3/5/7 frames Automatic Exposure Bracketing (AEB): 12 MP, 3/5 Frames at 0.7EV Step Timed: 12 MP 2/3/5/7/10/15/20/30/60 seconds SmartPhoto: 12 MP HDR Panorama: Vertical (3×1): 3328×8000 pixels (W×H) Wide (3×3): 8000×6144 pixels (W×H) 180° Panorama (3×7): 8192×3500 pixels (W×H) Sphere (3×8+1): 8192×4096 pixels (W×H)
Video Resolution	4K Ultra HD: 3840×2160 24/25/30/48/50/60 fps 2.7K: 2688×1512 24/25/30/48/50/60 fps FHD: 1920×1080 24/25/30/48/50/60/120/240 fps 4K Ultra HD HDR: 3840×2160 24/25/30 fps 2.7K HDR: 2688×1512 24/25/30 fps FHD HDR: 1920×1080 24/25/30 fps
Max Video Bitrate	120 Mbps
Supported File System	FAT32 exFAT (recommend)
Photo Format	JPEG/DNG (RAW)
Video Format	MP4/MOV (H.264/MPEG-4 AVC, H.265/HEVC)

Remote Controller	
Operating Frequency	2.400-2.4835 GHz, 5.725-5.850 GHz
Max Transmission Distance (unobstructed, free of interference)	10 km (FCC) 6 km (CE) 6 km (SRRC) 6 km (MIC)
Operating Temperature	14° to 104° F (-10° to 40° C)
Transmitter Power (EIRP)	2.400 - 2.4835 GHz: ≤26 dBm (FCC), ≤20 dBm (CE), ≤20 dBm (SRRC) , ≤20 dBm (MIC) 5.725 - 5.850 GHz: ≤26 dBm (FCC), ≤14 dBm (CE), ≤26 dBm (SRRC)
Battery Capacity	5200 mAh
Operating Current/Voltage	1200 mA@3.7 V (with Android device) 700 mA@3.7 V (with iOS device)
Max Supported Mobile Device Size (HxWxT)	180x86x10 mm
Supported USB Port Types	Lightning, Micro USB (Type-B), USB-C
Video Transmission System	OcuSync 2.0
Live View Quality	720p@30fps/1080p@30fps
Video Coding Format	H.265
Max Bitrate	12 Mbps
Latency (depending on environmental conditions and mobile device)	120-130 ms
Charger	
Input	100-240V, 50/60 Hz, 1.3 A
Output	Battery: 13.2 V = 2.82 A USB: 5V/2A
Rated Power	38 W
Intelligent Flight Battery	
Battery Capacity	3500 mAh
Voltage	11.55 V
Max Charging Voltage	13.2 V
Battery Type	LiPo 3S
Energy	40.42 Wh
Weight	198 g
Charging Temperature	41° to 104° F (5° to 40° C)
Max Charging Power	38 W
App	
App	DJI Fly
Required Operating System	iOS v10.0.2 or later; Android v6.0 or later
SD Cards	
Supported SD Cards	UHS-I Speed Grade 3 rating microSD card

Recommended microSD Cards

- SanDisk Extreme PRO 64GB U3 V30 A2 microSDXC
- SanDisk High Endurance 64GB U3 V30 microSDXC
- SanDisk Extreme 64GB U3 64GB V30 A2 microSDXC
- SanDisk Extreme 128GB U3 V30 A2 microSDXC
- SanDisk Extreme 256GB U3 A2 microSDXC
- Lexar 667x 64GB U3 V30 A2 microSDXC
- Lexar High-Endurance 64GB U3 V30 microSDXC
- Samsung EVO Plus (Yellow) 64GB U3 V30 microSDXC
- Samsung EVO Plus (Red) 64GB U3 microSDXC
- Samsung EVO Plus 128GB U3 microSDXC
- Samsung EVO Plus 256GB U3 microSDXC
- Kingston V30 128GB U3 microSDXC
- Netac 256GB U3 A1 microSDXC

Calibrating the Compass

It is recommended that the compass is calibrated in any of the following situations when flying outdoors:

1. Flying at a location further than 31 miles (50 km) away from the location the drone was last flown.
2. The aircraft has not been flown for more than 30 days.
3. A compass interference warning appears in DJI Fly and/or the aircraft status indicator blinks red and yellow alternatively.



- DO NOT calibrate the compass in locations where magnetic interference may occur, such as close to magnetite deposits or large metallic structures such as parking structures, steel reinforced basements, bridges, cars, or scaffolding.
- DO NOT carry objects (such as mobile phones) that contain ferromagnetic materials near the aircraft during calibration.
- It is not necessary to calibrate the compass when flying indoors.

Calibration Procedure

Choose an open area to carry out the following procedure.

1. Tap System Settings in DJI Fly, select Control, then select Calibrate, and follow the on-screen instructions. The aircraft status indicator blinks yellow, indicating calibration has start.
2. Hold the aircraft horizontally and rotate it 360°. The aircraft status indicator will turn solid green.
3. Hold the aircraft vertically and rotate it 360° around a vertical axis.
4. If the aircraft status indicator blinks red, the calibration has failed. Change your location and try the calibration procedure again.

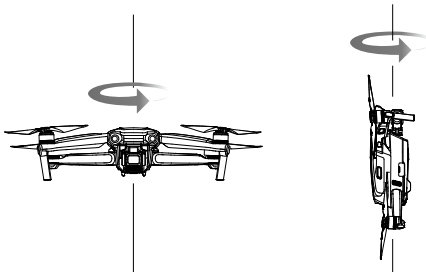



- If the aircraft status indicator blinks red and yellow alternately after calibration is completed, this indicates that the current location is not suitable for flying the aircraft, due to the level of magnetic interference. Change your location.



- A prompt will appear in DJI Fly if compass calibration is required before takeoff.
- The aircraft can take off immediately once calibration is complete. If you wait more than three minutes to take off after calibration, you may need to calibrate again.

Firmware Update

Use DJI Fly or DJI Assistant 2 for Mavic to update the aircraft firmware.

Using DJI Fly

When you connect the aircraft or remote controller to DJI Fly, you will be notified if a new firmware update is available. To start updating, connect your mobile device to the internet and follow the on-screen instructions. Note that you cannot update the firmware if the remote controller is not linked to the aircraft. Internet is required.

Using DJI Assistant 2 for Mavic

Update the aircraft and remote controller firmware separately using DJI Assistant 2 for Mavic.

Follow the instructions below to update the aircraft firmware through DJI Assistant 2 for Mavic:

1. Launch DJI Assistant 2 for Mavic and log in with your DJI account.
2. Power on the aircraft, and then connect the aircraft to a computer via the USB-C port.
3. Select Mavic Air 2 and click on Firmware Updates on the left panel.
4. Select the firmware version that you wish to update to.
5. Wait for the firmware to download. The firmware update will start automatically.
6. The aircraft will reboot automatically after the firmware update is complete.

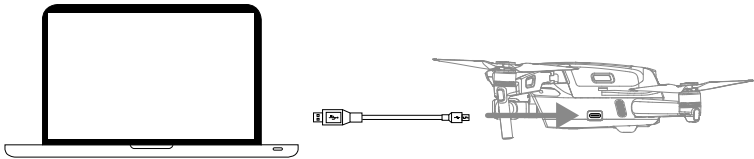

Follow the instructions below to update the remote controller firmware through DJI Assistant 2 for Mavic:

1. Launch DJI Assistant 2 for Mavic and log in with your DJI account.
2. Power on the remote controller and connect to a computer via the USB-C port using a Micro USB cable.
3. Select Mavic Air 2 Remote Controller and click on Firmware Updates on the left panel.
4. Select the firmware version that you wish to update to.
5. Wait for the firmware to download. The firmware update will start automatically.
6. Wait for the firmware update to be completed.

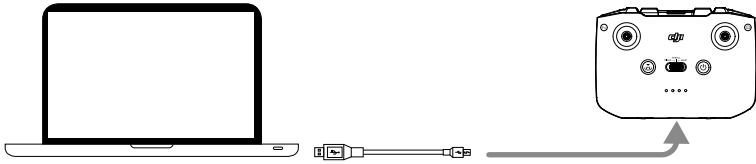

- Make sure follow all the steps to update firmware. Otherwise, the update may fail.
 - The firmware update will take approximately 10 minutes. It is normal that the gimbal goes limp, aircraft status indicators blink, and the aircraft reboots. Wait patiently until the update is complete.
 - Make sure the computer has access to the internet.
 - Before performing an update, make sure the Intelligent Flight Battery is at least 40% charged and the remote controller is at least 30% charged.
 - Do not disconnect the aircraft from the computer during an update.
-

After-sales Information

Visit <https://www.dji.com/support> to learn more about after-sales service policies, repair services, and support.

DJI Support
<http://www.dji.com/support>

This content is subject to change.

Download the latest version from
<http://www.dji.com/mavic-air-2>

If you have any questions about this document, please contact
DJI by sending a message to **DocSupport@dji.com**.

MAVIC is a trademark of DJI.

Copyright © 2020 DJI All Rights Reserved.